

FUNCTIONAL FORMS

LEXAN™ THERMOCLICK™ SHEET IN 40 MM

LTC404X4000 TECHNICAL MANUAL

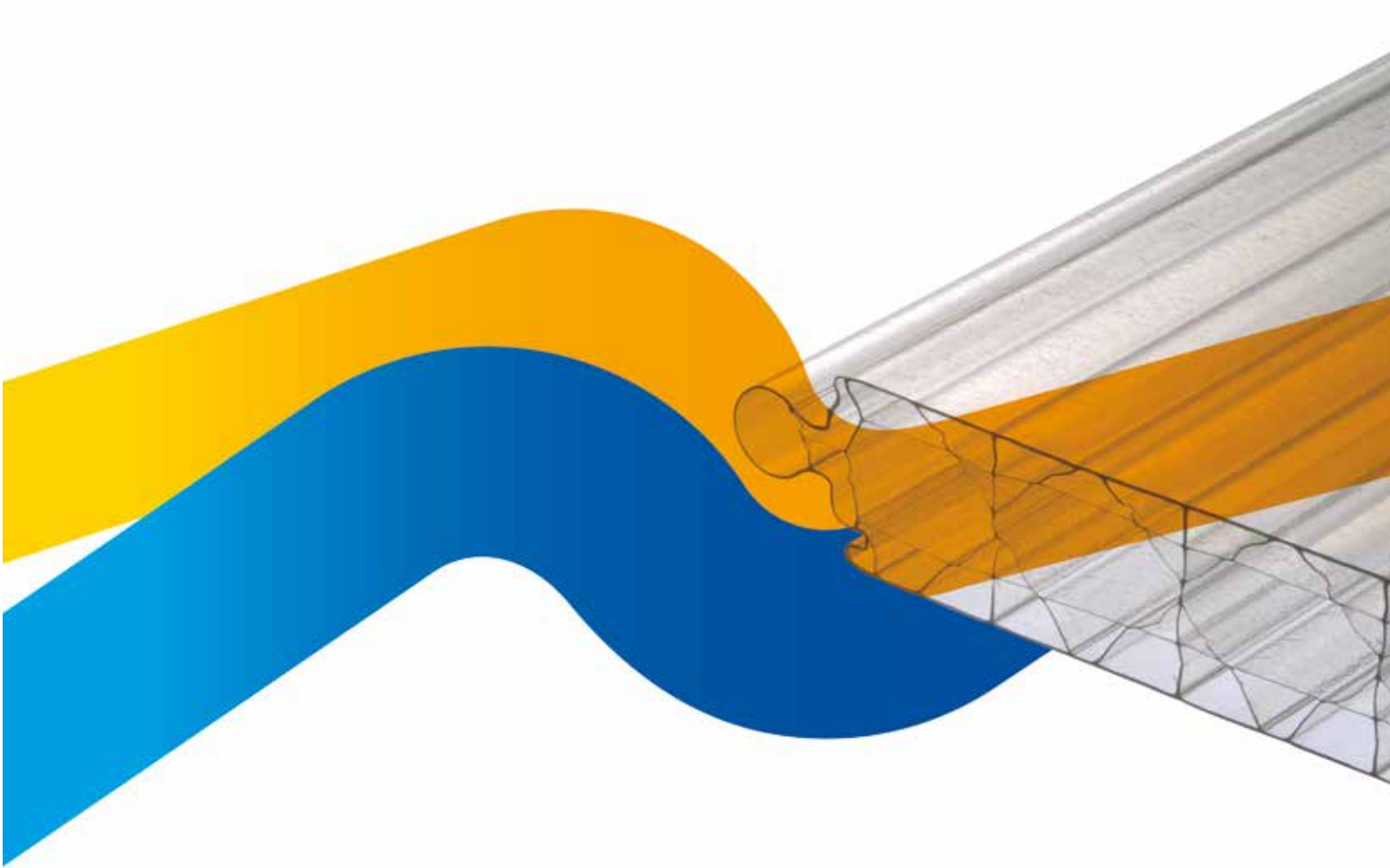



INDEX

INTRODUCTION	4
LEXAN™ THERMOCLICK™ sheet mechanical properties	6
GENERAL GUIDELINES	7
Installation guidelines	7
Wind and Snow Loading	9
INSTALLATION GUIDELINES	10

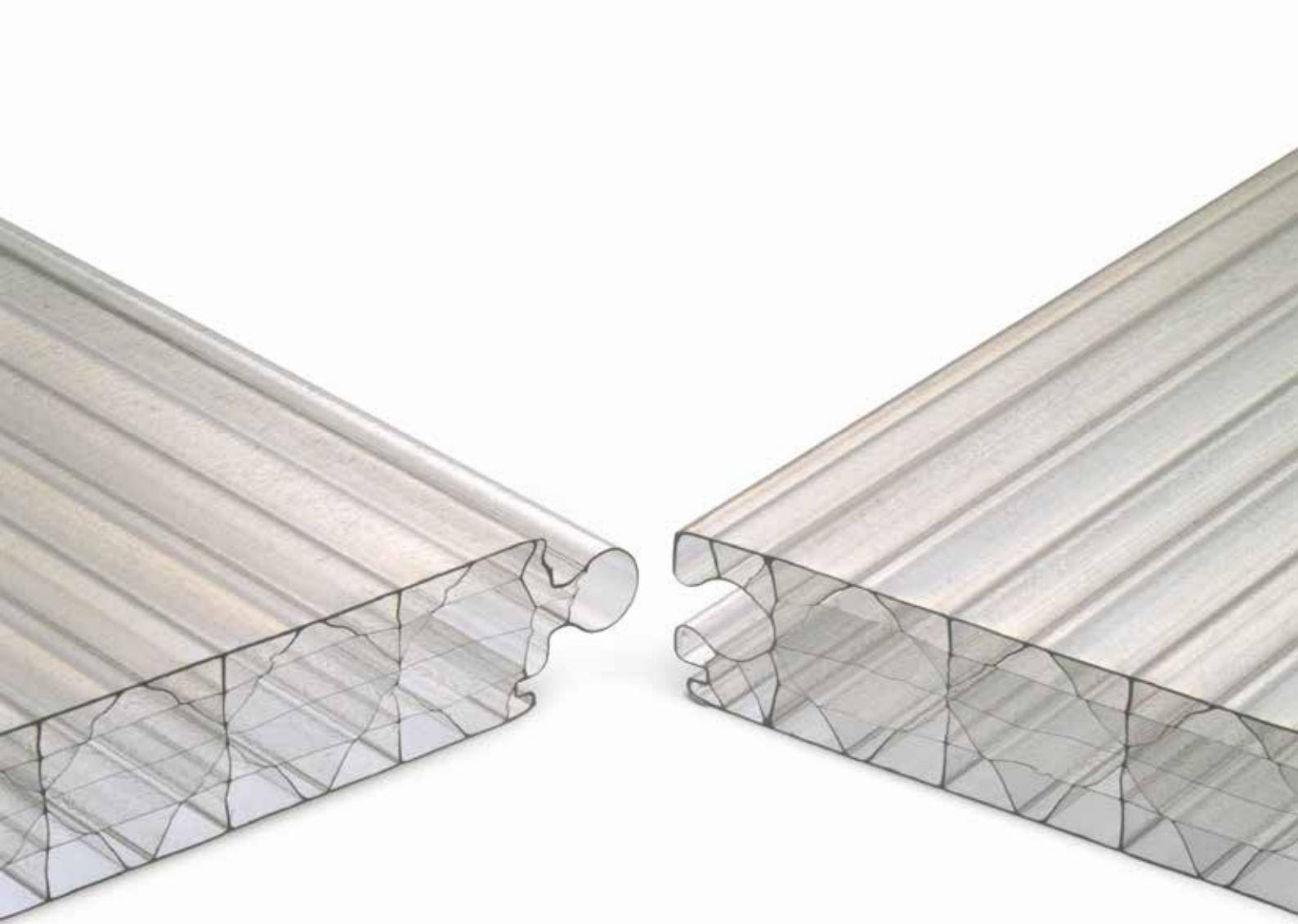

INTRODUCTION

LEXAN™ POLYCARBONATE

LEXAN™ polycarbonate is a unique engineering thermoplastic which combines a high level of mechanical, optical and thermal properties. When extruded in multi-wall sheet form, its optical and impact properties in particular render this material a strong candidate for a wide range of glazing applications.

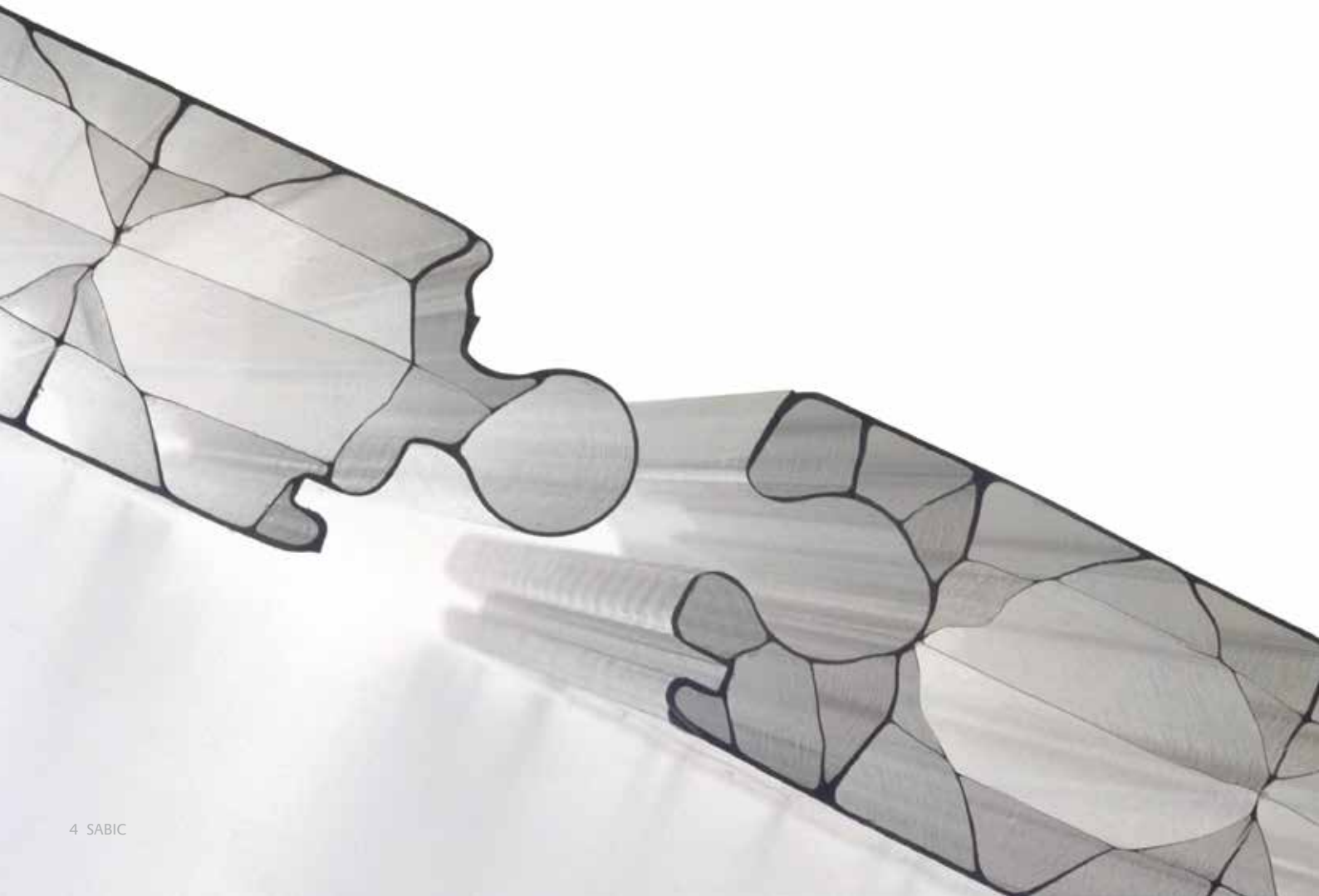

LEXAN™ THERMOCLICK™ SHEET

LEXAN™ THERMOCLICK™ sheet LTC404X4000, is an impact resistant, energy-saving multi-wall sheet with profiled tongue and groove connection, including a groove for double sided tie on the inside. This inter-connecting system eliminates the need for vertical profiles, thereby saving costs and enhancing aesthetics.

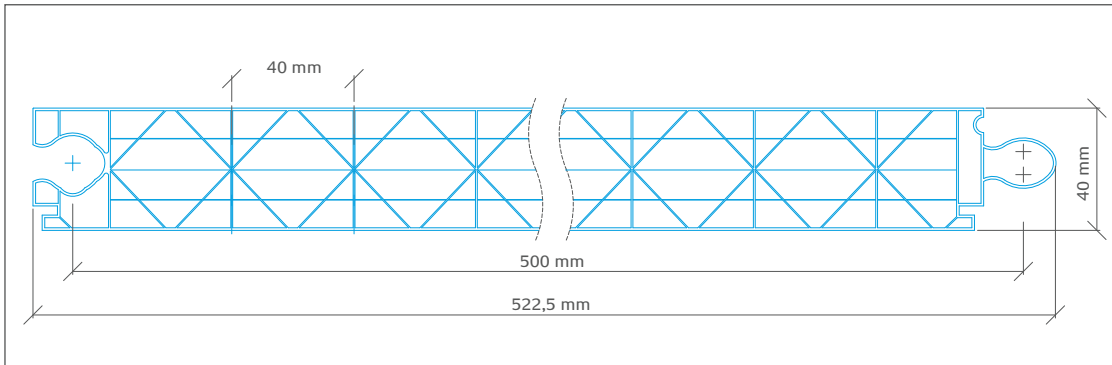

LEXAN™ THERMOCLICK™ sheet LTC404X4000 offers

- Unique four wall with X-structure
- UV protected outer surface
- Good light transmission and light diffusion characteristics
- Extremely high stiffness
- Excellent thermal insulation of 1.27 W/m² K
- High impact strength
- Long-term limited warranty weather resistance
- Easy and fast installation
- Wide range of colors and aesthetic effects

Property Profile	Value	Test Method
Panel width ctc	500 mm ±2.5 mm	
Standard length	≤ 6 meter -0 +20 mm	
	> 6 meter -0 +30 mm	
Panel total thickness	40 mm ±0.8 mm	
Weight	4 kg/m ² ±5%	
Hail impact	diam. 20 mm v = 21m/sec	TNO Test
Temperature resist.	-40 up to +100°C	UL 746 BEN
Fire Rating	B, S ₁ , d0	EN13501
U-Value	1.27 W/m ² K	ISO 10077 (EN673)
Sound insulation	21dB	EN ISO 10140-2:2010
Coeff. of linear thermal expansion	7 x 10 ⁻⁵ 1/K	ISO 11359-2

LEXAN THERMOCLICK SHEET MECHANICAL PROPERTIES

Impact Strength

LEXAN THERMOCLICK sheet has outstanding impact performance over a wide temperature range of -40°C to +100°C. The product has been shown capable of withstanding many kinds of extreme weather, storms, hailstones, snowfall and ice formation.

Hail simulation

As a glazing material LEXAN THERMOCLICK sheet is subject to extremes of weather; storms, hailstones, wind, snowfalls and ice formation. Under these conditions, the product is virtually unbreakable and is able to withstand the subsequent temperature change to sunny conditions without breaking or buckling.

In a test developed by the Dutch Testing Institute TNO, samples of LEXAN THERMOCLICK sheet have been subjected to simulated hailstones of varying diameters without significant damage. Polyamide balls of varying diameters are shot at the surface of the THERMOCLICK sample using a pressurized airgun.

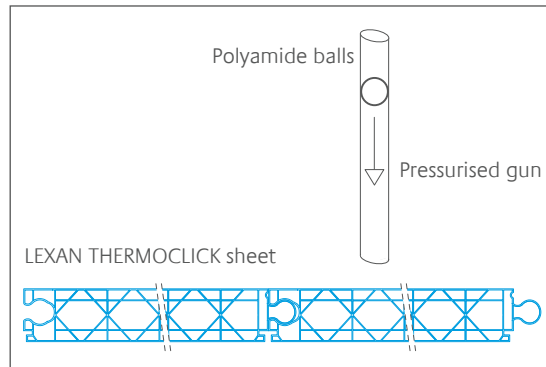

1.2

In practice, hailstones with a diameter of 20 mm can reach a terminal velocity of 21 m/s. Under these conditions, traditional roof glazing materials such as glass and acrylic fail.

It should be noted that when the glass and the acrylic are tested, their failure characteristics are typically brittle, while the LEXAN THERMOCLICK sheet shows ductile behavior - upon impact the ball will leave indentations but the sheet will not break.

Hail Simulation Test Results	Simulation
Material	Velocity with ball diameter 20 mm
Acrylic multi-wall sheet t=16 mm	7-14 m/s
Float glass t=4 mm	10 m/s
LEXAN THERMOCLICK sheet t=40 mm	21 m/s
Equilibrium velocity of hail	21 m/s

UV protection

LEXAN THERMOCLICK sheet has one proprietary UV protected surface to help protect the system against the degrading effects of ultra violet radiation of sunlight and promotes long-term optical quality under many kinds of severe weather conditions. This UV protected surface, indicated on the masking, should always face outwards.

Light / solar transmission properties

Solar heat gain within a building is caused by heat input from radiation emitted from the sun. Sunlight entering the building heats the air both directly and through absorption by the framework, furniture, etc. and is released as infrared energy. In combination with the insulating properties of LEXAN THERMOCLICK sheet, this prevents heat escaping faster than it is created causing a temperature increase, the so-called 'green-house effect'. The temperature can be controlled by venting, often in combination with specially tinted opal white or LEXAN THERMOCLICK Solar Control IR™ sheet which contains a proprietary additive which selectively absorbs the near infrared region of the light. LEXAN THERMOCLICK sheet is therefore available in many different colors or with IR additives which both cut down the brightness of sunlight to a pleasing level and reduces heat build up inside the building. Calculations for solar heat input through glazing are normally based on data published in "The Institution of Heating and Ventilating Engineers Guide Book". These calculations are based on clear glass and correction factors or shading coefficients and are then applied when alternative glazing materials are used.

THERMOCLICK colors

Color	Color	LT**	Direct ST***	Total ST***	Solar Heat Gain Coeff.#	Shading Coeff.##
LTC404X4000						
Clear	112	59%	56%	64%	0.64	0.73
Opal white	WH7A092X	50%	48%	57%	0.57	0.66
Blue	BL6C024T	20%	38%	51%	0.51	0.58
Green	GN7C018T	46%	44%	55%	0.55	0.63
Purple	VT5C010T	15%	41%	54%	0.54	0.62
Red	RD7C005T	27%	44%	56%	0.56	0.64
Orange	OR6C012T	34%	42%	59%	0.59	0.68
Yellow	YW9C007T	59%	52%	61%	0.61	0.70
LTCIR404X40						
Green	GN8B038T	38%	23%	40%	0.40	0.46
Grey	GY5B422T	14%	13%	32%	0.32	0.37
Blue	BL8B089T	23%	19%	37%	0.37	0.42

** Light Transmission (LT) and Direct Solar Transmission (Direct ST) acc. EN 410 as measured on 600 mm x 600 mm samples

*** Total Solar Transmission (Total ST) acc. EN 410 is the total solar energy that enters the interior of a building

Solar heat gain coefficient or g-value is the total solar energy that enters the interior of a building, divided by 100

Shading coefficient or b-value is the ratio of the total solar energy that enters the interior of a building with a given material and the total solar energy that enters the interior of a building with a standard 3 mm glass panel

** SABIC offers a Ten Years Limited Warranty on LEXAN THERMOCLICK sheet covering loss of strength or impact due to weathering.

*** SABIC offers a ten year limited written warranty on LEXAN THERMOCLICK sheet covering discoloration, loss of light transmission and loss of impact strength due to weathering as more specifically defined in such warranty. Please consult your local distributor or SABIC Sales Office for more details.

GENERAL GUIDELINES

Thermal insulation

The multi-wall structure of LEXAN THERMOCLICK sheet offers potential advantages where thermal insulation is a major consideration. The amount of energy transmitted through the material per square meter and per degree temperature difference, referred to as U-Value, is only 1.27 W/m²K.

Temperature resistance

LEXAN THERMOCLICK sheet is characterized by its excellent retention of impact strength and stiffness at elevated temperatures, even over an extended period. LEXAN THERMOCLICK sheet has a continuous use temperature rating of -40°C up to +100°C.

Fire test performance

LEXAN THERMOCLICK sheet has good fire performance in accordance with many national fire standards. More detailed information is available from SABIC's service center or your local authorized dealer.

Storage

LEXAN THERMOCLICK sheet should be stored and protected against atmospheric influences like sun, rain, etc. Care should be exercised when handling and transporting LEXAN THERMOCLICK sheet in order to prevent scratches on the panel surface and damage to the panel edges.

Sawing

LEXAN THERMOCLICK sheet can be cut easily and accurately with most standard workshop equipment. This includes common circular, hand and hacksaws both with fine-toothed blades. The panel should be clamped to the worktable to avoid undesirable vibration and the sawdust should be blown out of the channels.

INSTALLATION GUIDELINES

Sealing recommendations

In order to minimize moisture build-up and dust contamination inside the channels, edge sealing of the open ended channels is very important. An impermeable tape and a perforating venting tape have been developed by the company Multifoil. Both tapes are available via your local authorized dealer.

Standard glazing

For standard glazing applications it is generally recommended to seal the top end channels with an impermeable tape and the bottom end channels with an anti-condensation venting tape. A clearance between the bottom panel end and the sash profile platform helps allow for condensation drainage.

Specific conditions

In extremely dusty environments such as sawmills, welding stations, etc., it is usually advisable to seal both the top and bottom channel ends with an impermeable tape.

Thermal expansion allowance

Take into account a clearance of approximately 3 mm per linear meter between panel top edge and top glazing profile platform, and between the first and last panel side and side glazing profile platform. This thermal expansion clearance is already taken into account when using the special developed top and bottom glazing profiles indicated in this chapter.

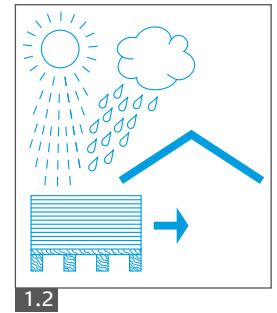

1.2

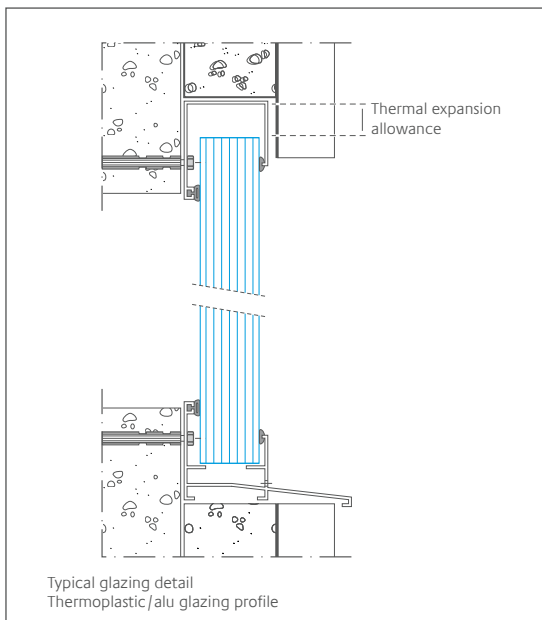

1.3

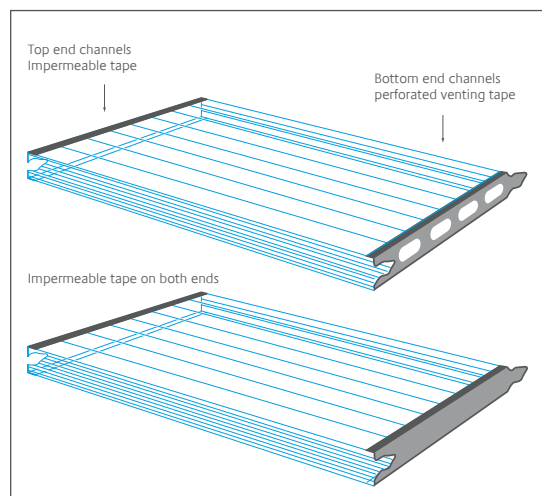

1.4

LEXAN™ SHEET CLEANING RECOMMENDATIONS

These cleaning recommendations apply to all LEXAN polycarbonate sheet products, including, but not limited to, LEXAN solid sheet and signs, LEXAN coated MARGARD™ sheet and LEXAN multiwall sheet. Periodic cleaning using correct procedures can help to prolong service life. For cleaning, it is recommended that the following instructions be adhered to:

Cleaning Procedure for Small Areas – Manual

1. Gently wash sheet with a solution of mild soap and lukewarm water, using a soft, grid-free cloth or sponge to loosen any dirt or grime.
2. Fresh paint splashes, grease and smeared glazing compounds can be removed easily before drying by rubbing lightly with a soft cloth using petroleum ether (BP65), hexane or heptane. Afterwards, wash the sheet using mild soap and lukewarm water.
3. Scratches and minor abrasions can be minimized by using a mild automobile polish. We suggest that a test be made on a small area of LEXAN sheet with the polish selected and that the polish manufacturer's instructions be followed, prior to using the polish on the entire sheet.
4. Finally, thoroughly rinse with clean water to remove any cleaner residue and dry the surface with a soft cloth to prevent water spotting.

Cleaning Procedure for Large Areas - Automated

1. Clean the surface using a high-pressure water cleaner (max. 100bar or 1,450psi) and/or a steam cleaner.
We suggest that a test be made on a small area, prior to cleaning the entire sheet.
2. Use of additives to the water and/or steam should be avoided.

Other Important Instructions for All LEXAN sheets:

- Never use abrasive or highly alkaline cleaner on LEXAN polycarbonate materials.
- Never use aromatic or halogenated solvents like toluene, benzene, gasoline, acetone or carbon tetrachloride on LEXAN polycarbonate materials.
- Use of incompatible cleaning materials with LEXAN sheet can cause structural and/or surface damage.
- Contact with harsh solvents such as methyl ethyl ketone (MEK) or hydrochloric acid can result in surface degradation and possible crazing of LEXAN sheet.
- Never scrub with brushes, steel wool or other abrasive materials.
- Never use squeegees, razorblades or other sharp instruments to remove deposits or spots.
- Do not clean LEXAN polycarbonate in direct sunlight or at high temperatures as this can lead to staining.
- For all mentioned chemicals consult the manufacturer's material safety datasheet (MSDS) for proper safety precautions.

Additional Important Considerations for Multiwall, Corrugated and Sign sheet:

- Cleaners and solvents generally recommended for use on polycarbonate are not necessarily compatible with the UV-protected surfaces of LEXAN multiwall, corrugated and sign polycarbonate materials.
- Do not use alcohols on the UV-protected surfaces of LEXAN sheet.
- Never clean the Drippard surface of LEXAN multiwall and corrugated sheets



WIND AND SNOW LOADING

Dynamic wind pressure

The wind speed is used to determine the actual loading upon the glazing panels. In mathematical terms, the pressure loading is calculated by multiplying the square of the design wind speed by 0.613.

$$p = KV^2$$

Where p = dynamic wind pressure in N/m^2 $K = 0.613$
 V = design wind speed in meters/second

Values of p in SI units (N/m^2)

Wind speed	Wind pressure	Wind speed	Wind pressure
m/s	N/m^2	m/s	N/m^2
10	61	40	981
15	138	45	1240
20	245	50	1530
25	383	55	1850
30	552	60	2210
35	751	65	2590

The Beaufort scale transforms wind into static pressure

Wind	Light	Moderate	Strong	Storm
Speed (km/h)	20	40-60	80-100	120-140
Speed (m/sec)	6	11-17	22-28	33-39
Static pressure (N/m^2)	20	80-170	300-480	680-950

Pressure coefficient

To allow for local fluctuations in the acceleration/ deceleration of the wind by building or glazing geometry, it is necessary to include an appropriate pressure coefficient. Determining pressure coefficients requires knowledge of

- Form and type of building
- Height of glazing
- Shape of glazing e.g.
 - flat vertical
 - inclined roofing
 - curved glazing

The wind loading is obtained by multiplying the dynamic wind pressure by the pressure coefficient. The total wind loading can be positive indicating a wind pressure load or negative indicating a wind suction load. Detailed pressure coefficient values can be found in the appropriate national building norms.

Snow loading

Snow loading on the roof glazings can be considered equivalent to a vertically, uniformly distributed load, acting per m^2 of the horizontal projection of the glazing. A roof made of LEXAN THERMOCLICK sheet does not permit immediate melting of the snow, due to its excellent thermal insulation, and therefore the load produced by the snow must be carefully taken into consideration.

Indicative snow weights per centimeter of height are as follows

- fresh snowfall - 0.8-1.9 kg/m^2 per cmh
- wet snowfall - 2-8 kg/m^2 per cmh

Snow loading factors can be obtained from the appropriate local building norm.

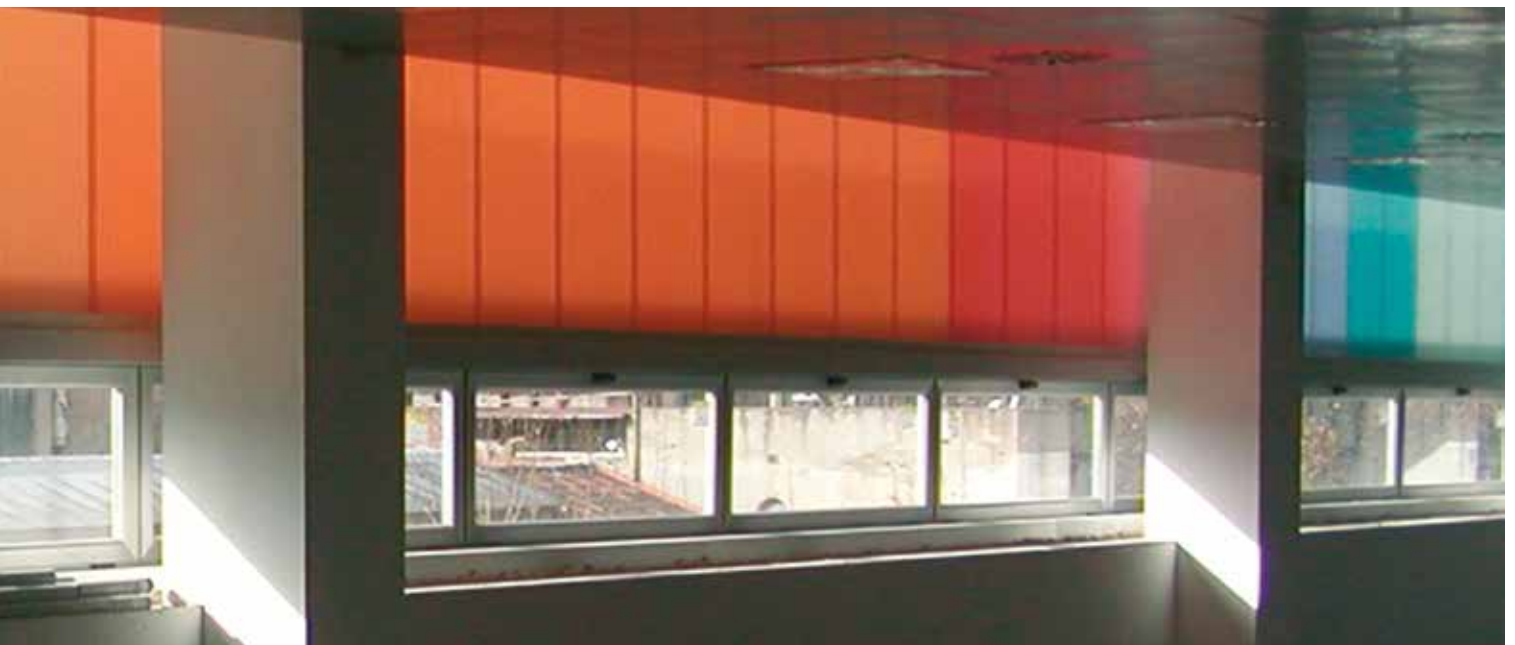

INSTALLATION GUIDELINES

Vertical wall glazing

This chapter illustrates some glazing proposals using commercially available aluminum glazing profiles which have been proven to be successful in combination with LEXAN THERMOCLICK sheet. A wide range of easy to use aluminum glazing profiles and metal fastener clips are available at the vast majority of authorized LEXAN THERMOCLICK sheet distributors and specialized installers. LEXAN THERMOCLICK sheet can be installed either from inside the building or from the outside.

When the glazing height exceeds the maximum recommended span 'H', intermediate horizontal purlins should be used to support the LEXAN THERMOCLICK sheet. LEXAN THERMOCLICK sheet may be fixed to these purlins using special non-rusting metal fastening clips positioned in the double sided tie on both panel sides. The distance between the horizontal intermediate purlins should not exceed the maximum recommended span dimensions 'P' as indicated in the table below.

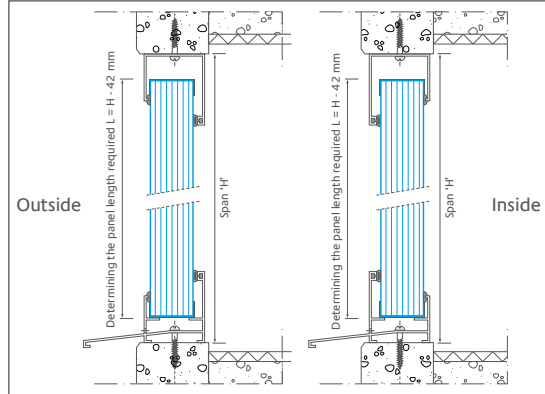

1.5

Maximum recommended span 'H'

LEXAN THERMOCLICK sheet glazing recommendations without intermediate purlins.

Wind suction, in N/m ²	Maximum recommended span 'H' in mm
600	2400
900	2100
1200	1800
1500	1600
1800	1400

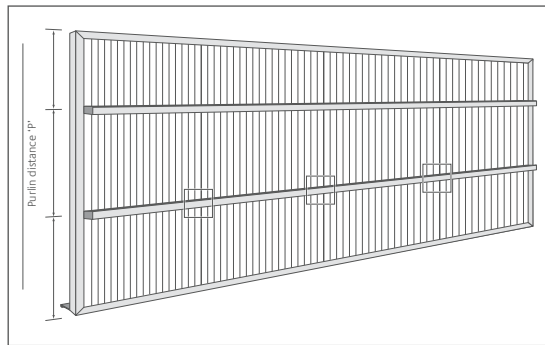

1.6

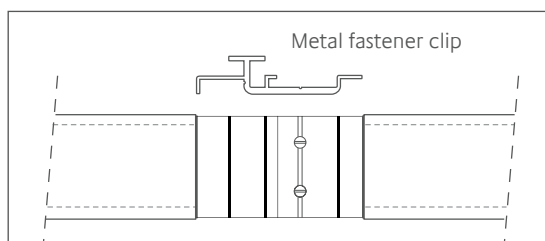

1.7

Maximum recommended span 'P'

LEXAN THERMOCLICK sheet glazing recommendations with intermediate purlins and clip length of 75 mm.

Wind suction, in N/m ²	Maximum recommended span 'P' in mm
600	2200
900	2000
1200	1800
1500	1600
1800	1400

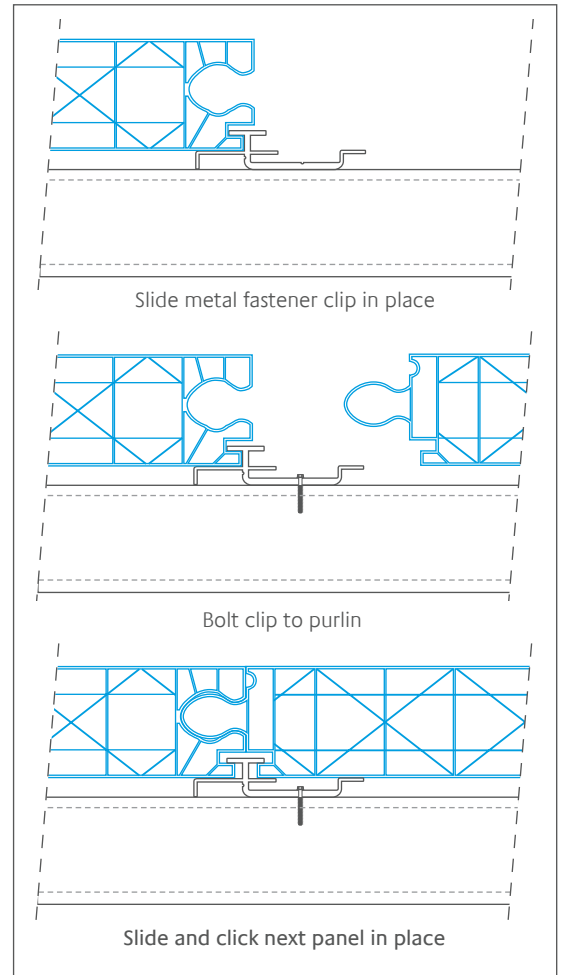

1.8

Alternative for connecting panels

Using the aluminum top and bottom glazing profiles, bolted to the intermediate purlins is a good alternative for connecting LEXAN THERMOCLICK sheet when the glazing height exceeds the maximum allowable span 'H'.

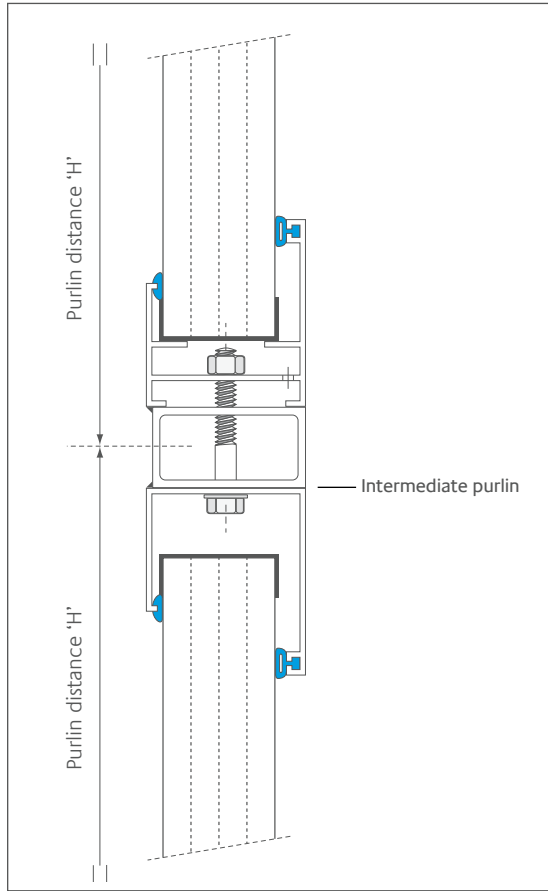

1.9



CONTACT US

Middle East and Africa

Global Headquarters

PO Box 5101
Riyadh 11422
Saudi Arabia
T +966 (0) 1 225 8000
F +966 (0) 1 225 9000
E info@sabic.com

Americas

Functional Forms

2500 City West Boulevard, Suite 100
Houston, TX 77042
USA
T 800 323 3783 (toll free)
T +1 413 448-6655
F (888) 443 2033
E sales.spinside@sabic-ip.com

Europe

Functional Forms

Plasticslaan 1
4612 PX
Bergen op Zoom
The Netherlands
T +31 (0)164 293678
F +31 (0)164 293272
E sfs.info@sabic.com

Asia Pacific

Functional Forms

2550 Xiupu Road
Pudong
201319 Shanghai
China
T +86 21 3222 4500
F +86 21 6289 8998
E sfs.info@sabic.com



DISCLAIMER: THE MATERIALS, PRODUCTS AND SERVICES OF SAUDI BASIC INDUSTRIES CORPORATION (SABIC) OR ITS SUBSIDIARIES OR AFFILIATES ("SELLER") ARE SOLD SUBJECT TO SELLER'S STANDARD CONDITIONS OF SALE, WHICH ARE AVAILABLE UPON REQUEST. INFORMATION AND RECOMMENDATIONS CONTAINED IN THIS DOCUMENT ARE GIVEN IN GOOD FAITH. HOWEVER, SELLER MAKES NO EXPRESS OR IMPLIED REPRESENTATION, WARRANTY OR GUARANTEE (i) THAT ANY RESULTS DESCRIBED IN THIS DOCUMENT WILL BE OBTAINED UNDER END-USE CONDITIONS, OR (ii) AS TO THE EFFECTIVENESS OR SAFETY OF ANY DESIGN OR APPLICATION INCORPORATING SELLER'S MATERIALS, PRODUCTS, SERVICES OR RECOMMENDATIONS. UNLESS OTHERWISE PROVIDED IN SELLER'S STANDARD CONDITIONS OF SALE, SELLER SHALL NOT BE RESPONSIBLE FOR ANY LOSS RESULTING FROM ANY USE OF ITS MATERIALS, PRODUCTS, SERVICES OR RECOMMENDATIONS DESCRIBED IN THIS DOCUMENT. Each user is responsible for making its own determination as to the suitability of Seller's materials, products, services or recommendations for the user's particular use through appropriate end-use and other testing and analysis. Nothing in any document or oral statement shall be deemed to alter or waive any provision of Seller's Standard Conditions of Sale or this Disclaimer, unless it is specifically agreed to in a writing signed by Seller. Statements by Seller concerning a possible use of any material, product, service or design do not, are not intended to, and should not be construed to grant any license under any patent or other intellectual property right of Seller or as a recommendation for the use of any material, product, service or design in a manner that infringes any patent or other intellectual property right.

Unless otherwise noted, SABIC and brands marked with ™ are trademarks of SABIC or its subsidiaries or affiliates. Any brands, products or services of other companies referenced in this document are the trademarks, service marks and/or trade names of their respective holders.
© 2016 Copyright SABIC. All rights reserved.